

1

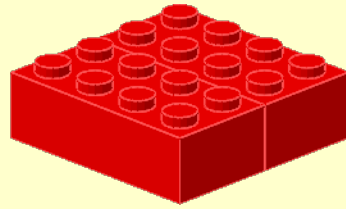

2

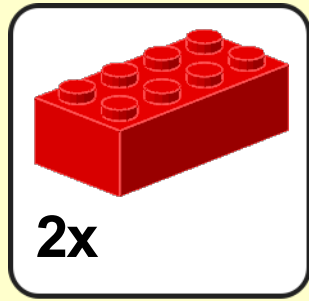
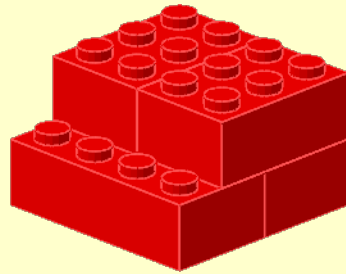
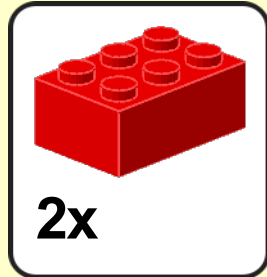

3

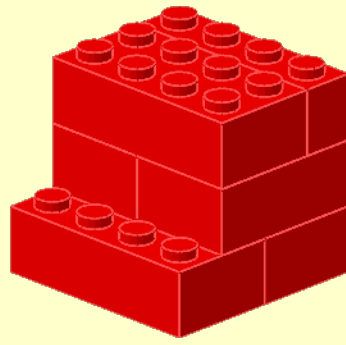
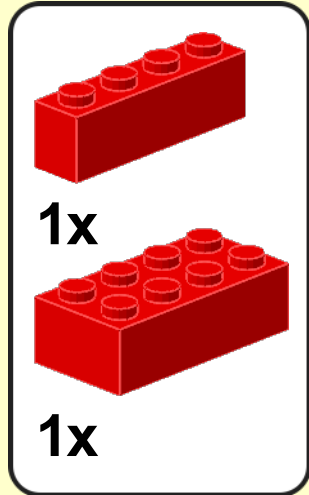

4

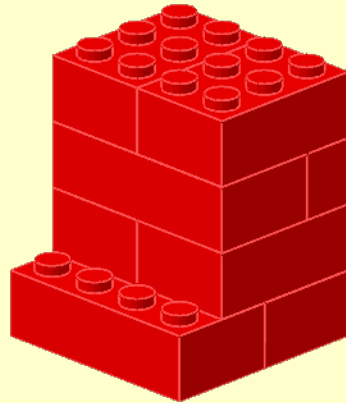
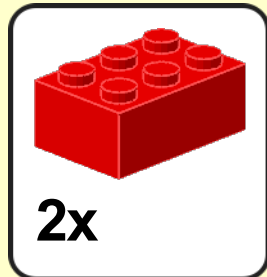

5

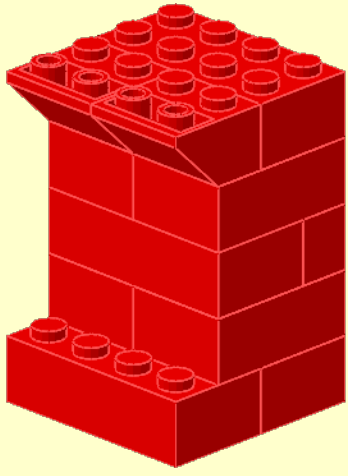
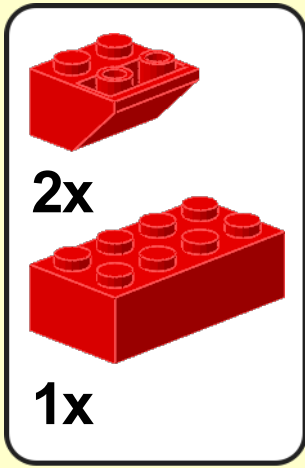

6

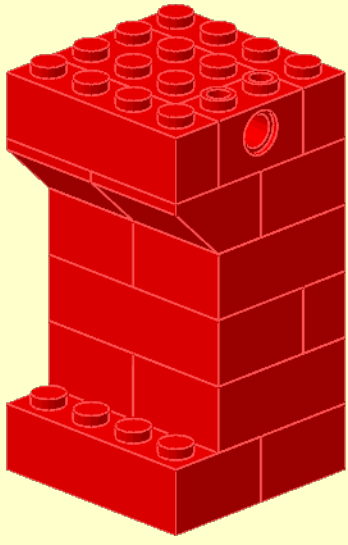
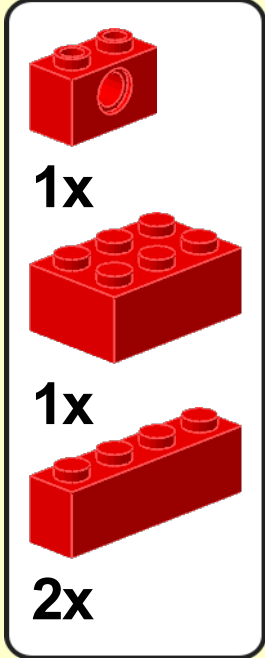

7

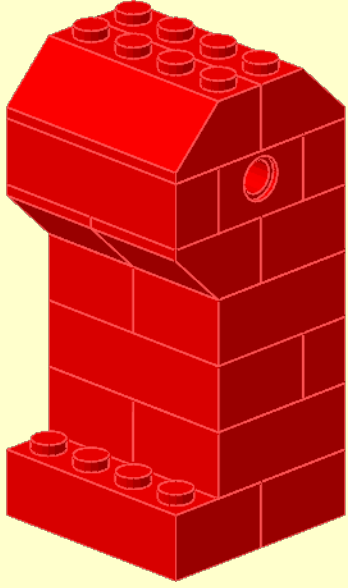
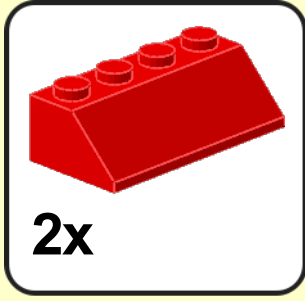

1

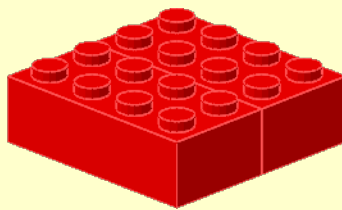
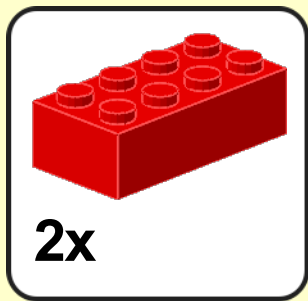

2

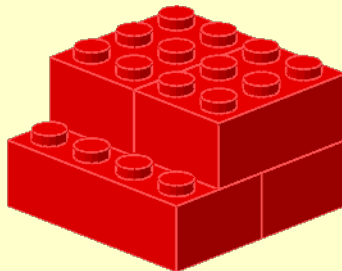
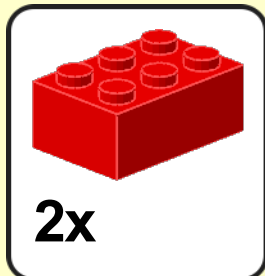

3

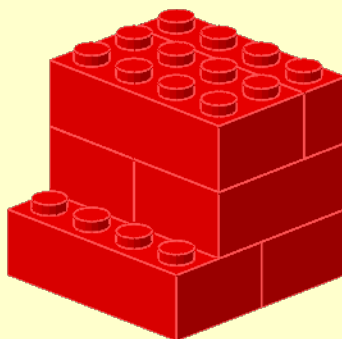
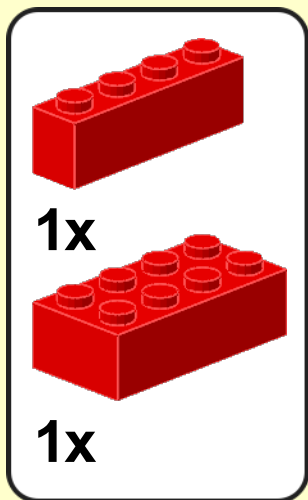

4

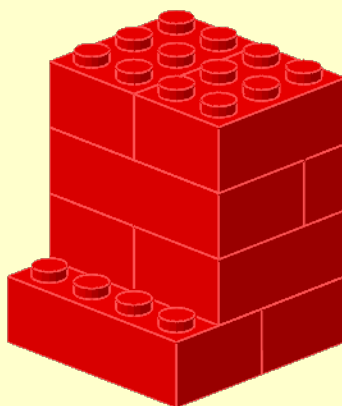
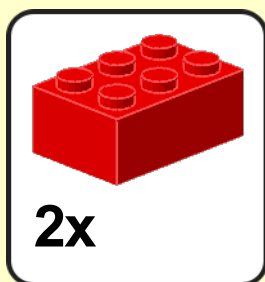

5

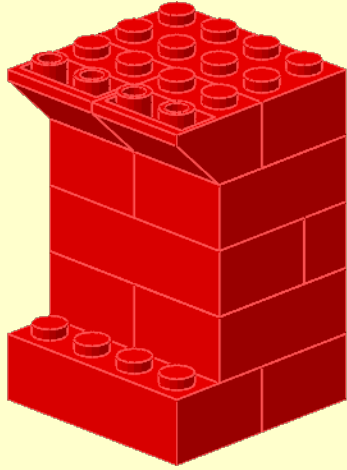
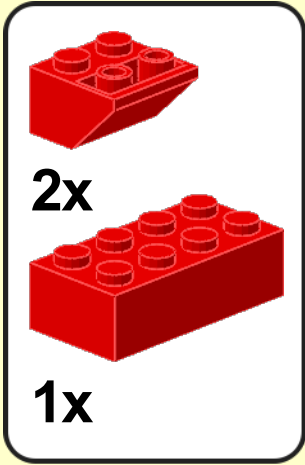

6

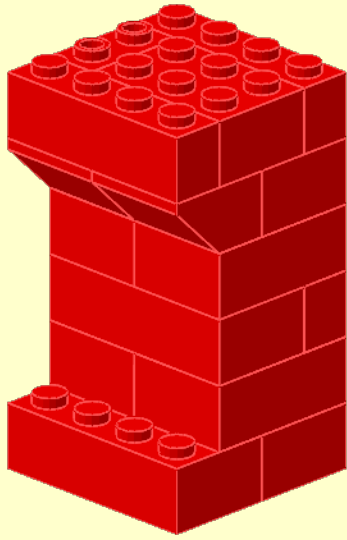
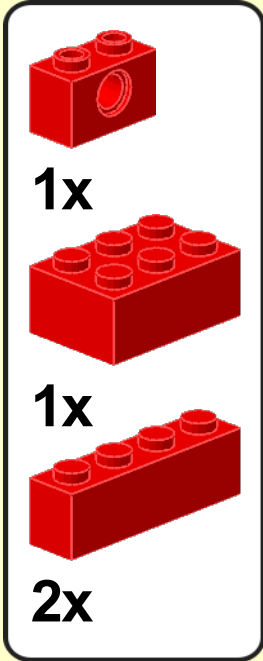

7

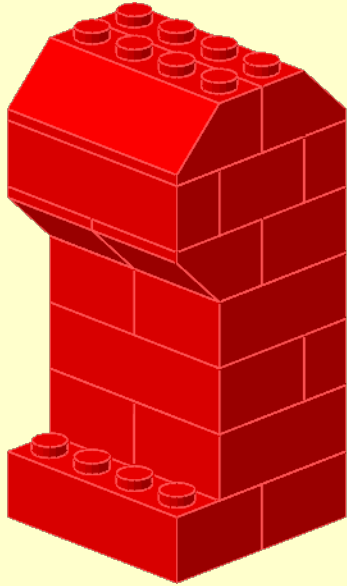
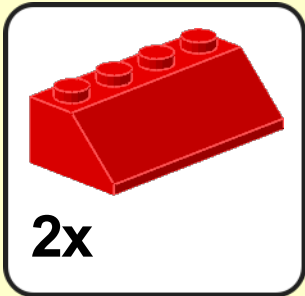

1

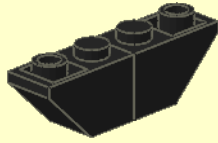

2

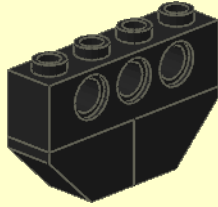
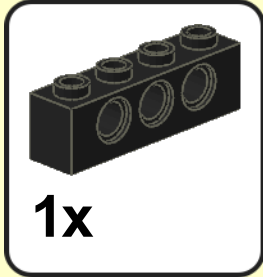

3

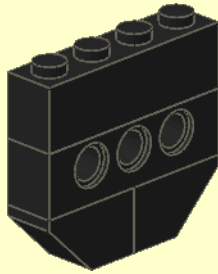
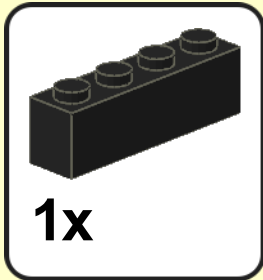

4

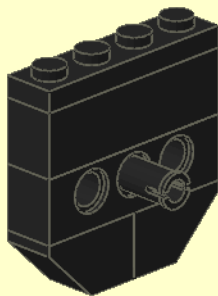
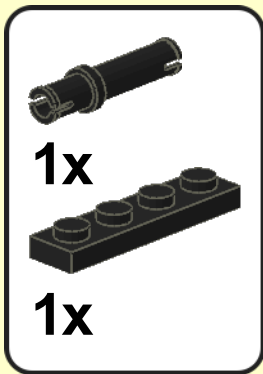

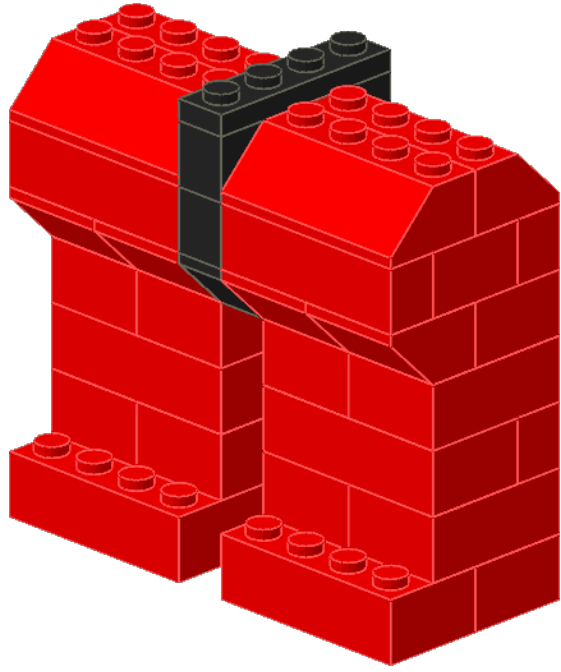

1

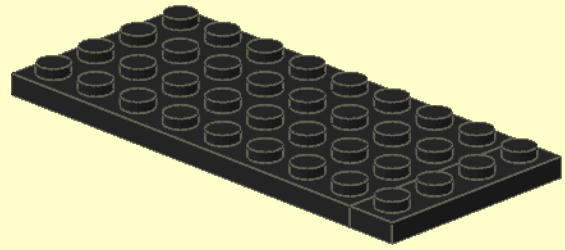
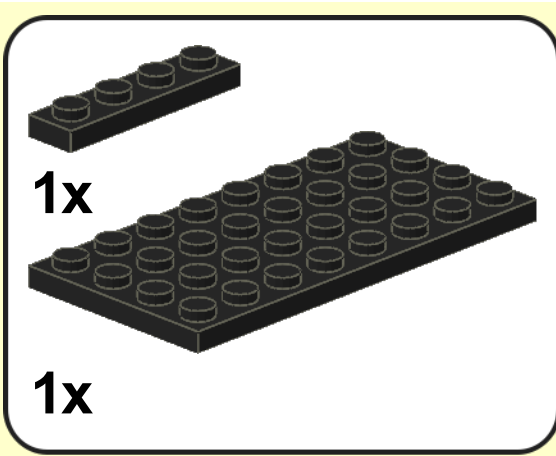

2

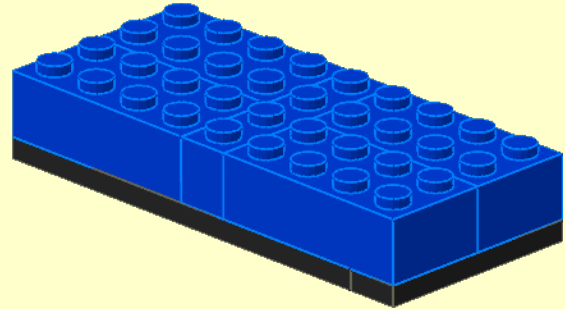
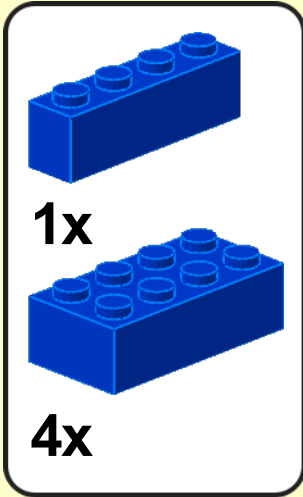

3

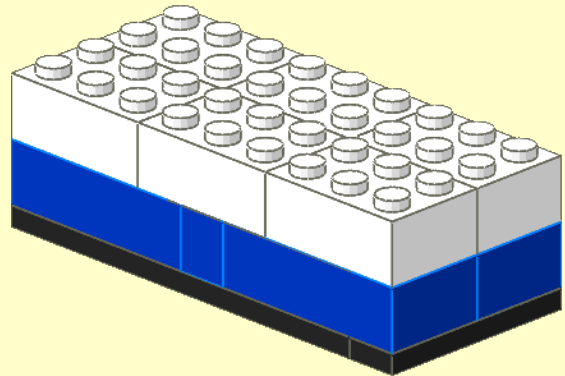
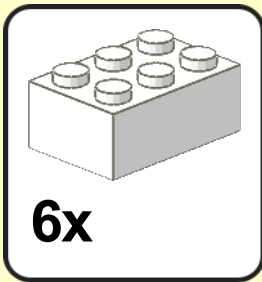

4

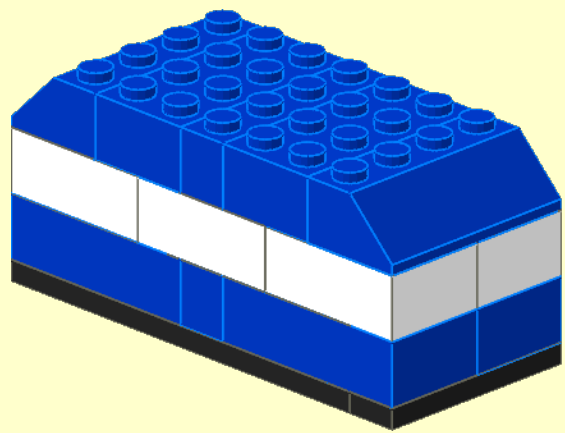
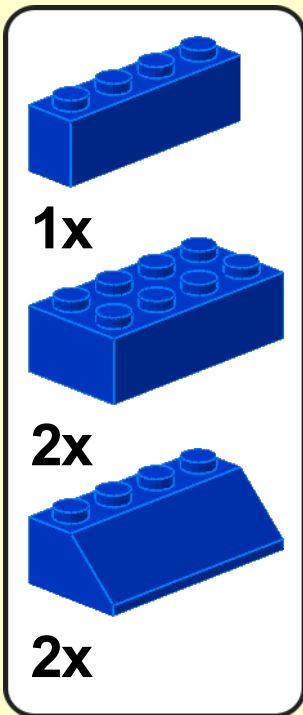

5

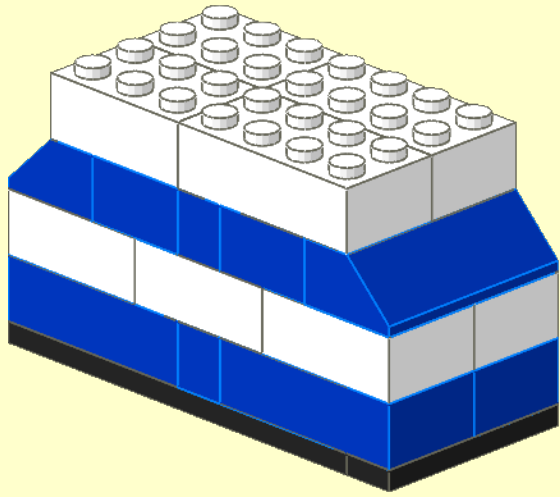
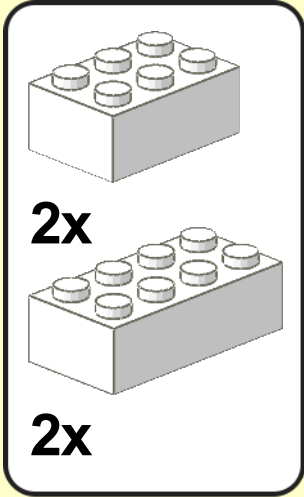

6

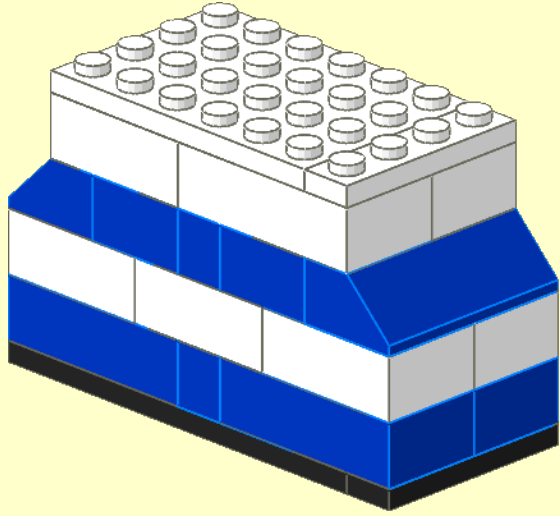
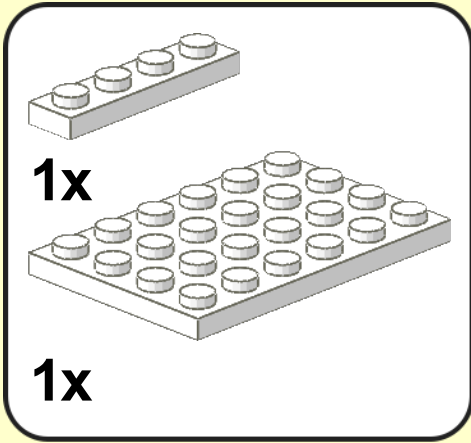

7

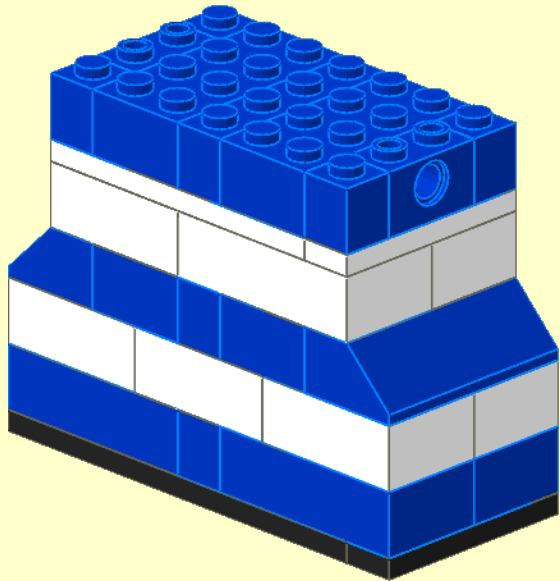
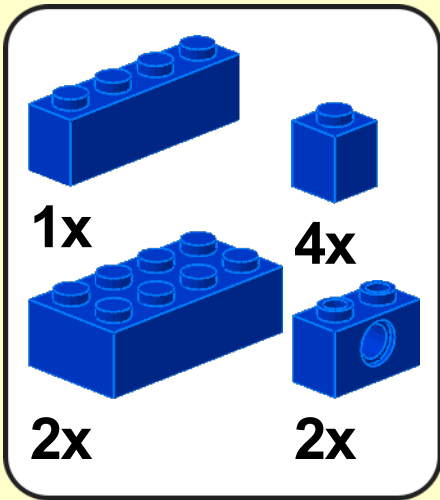



8

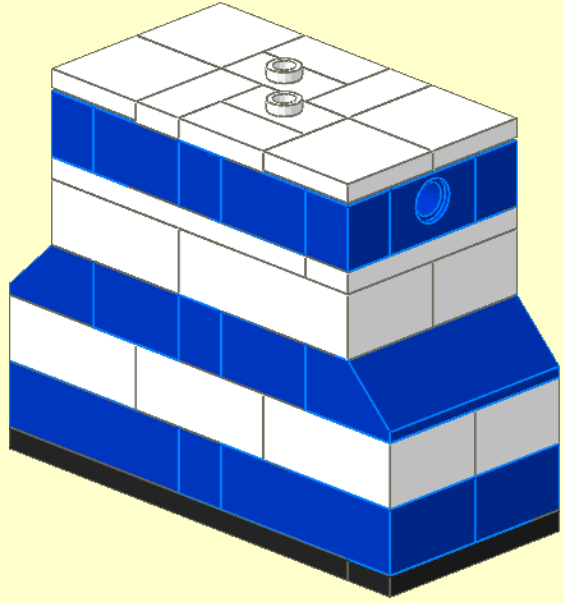
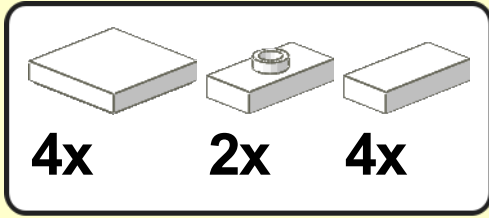

9

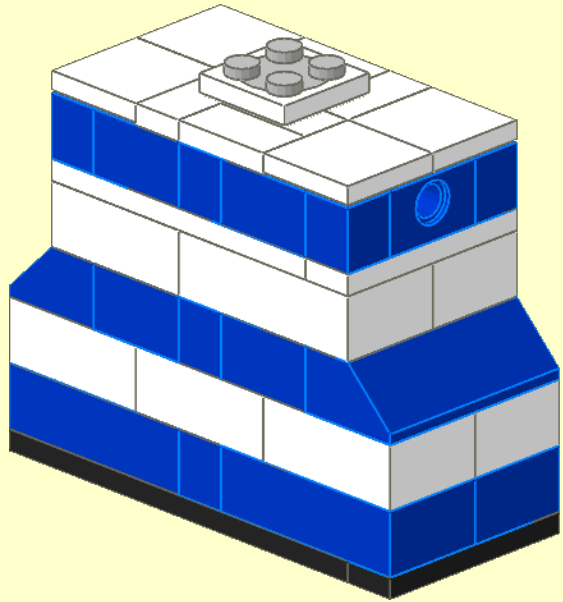
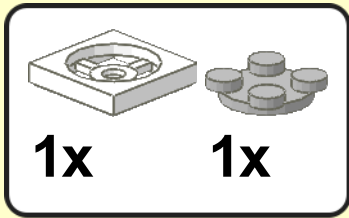

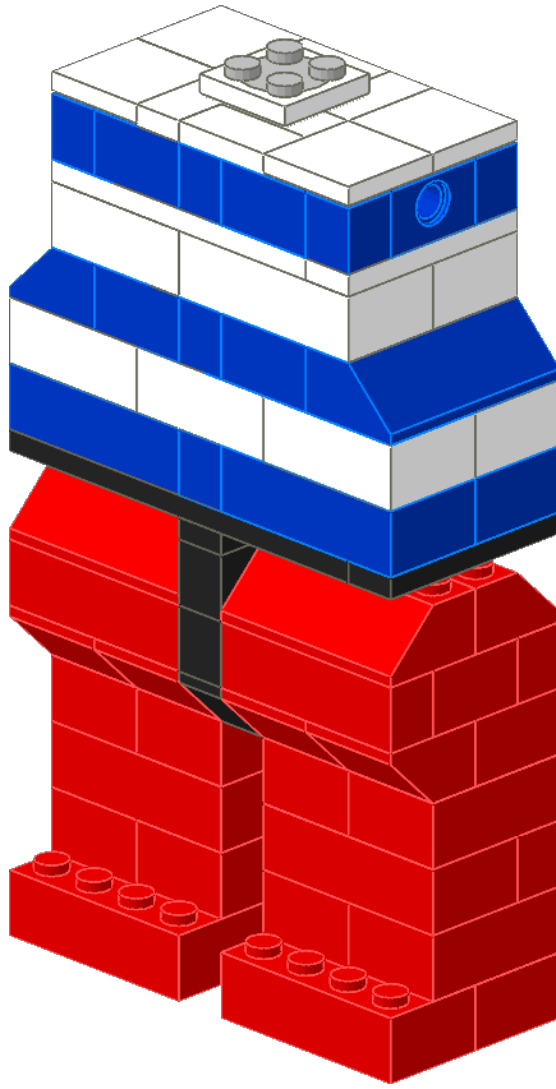

1

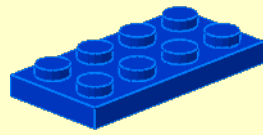
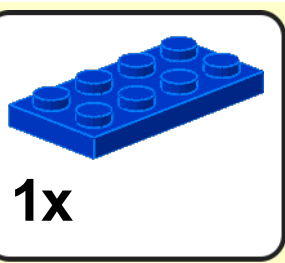

2

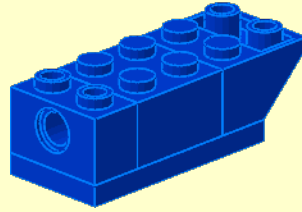
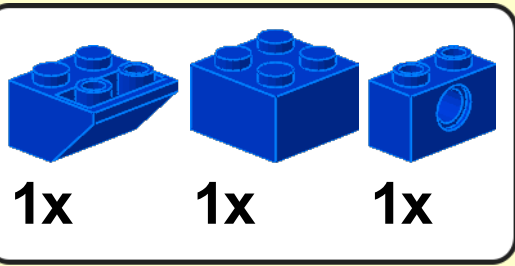

3

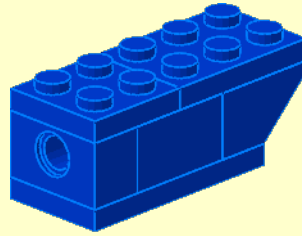
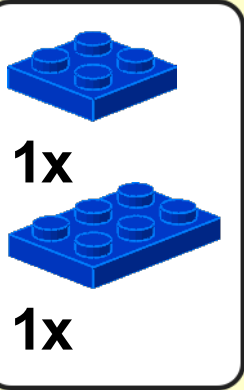

4

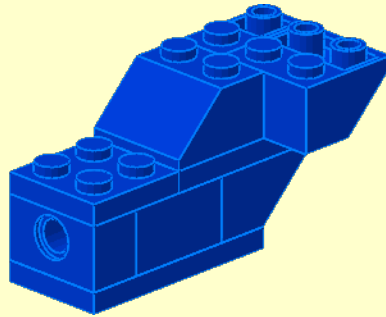
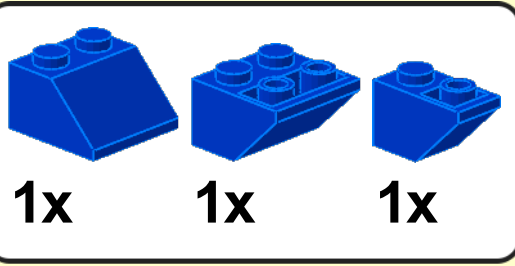

5

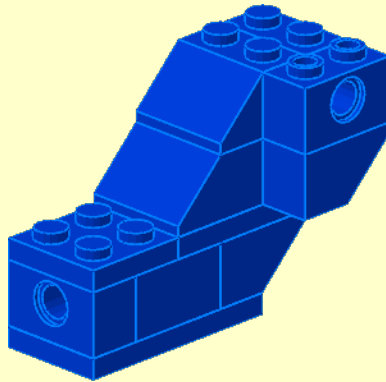
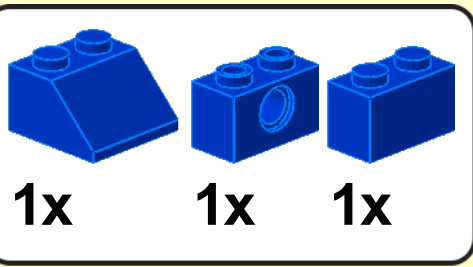

6

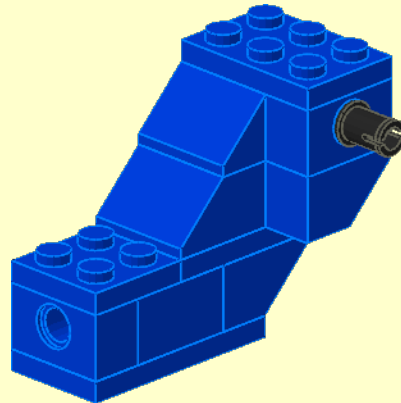
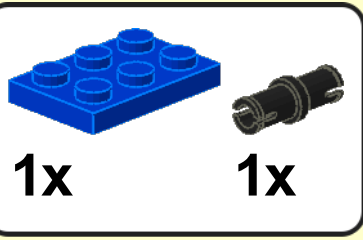

1

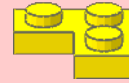
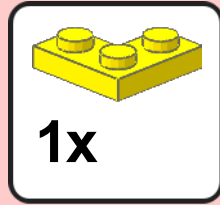

2

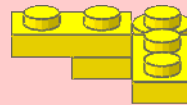
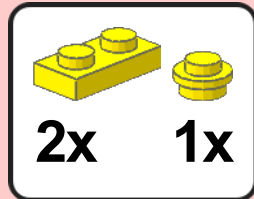

3

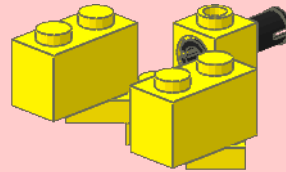
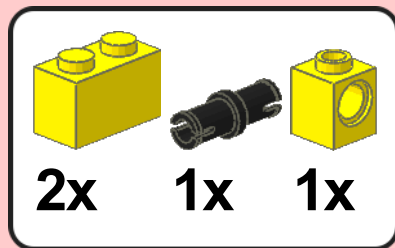

4

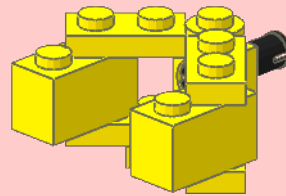
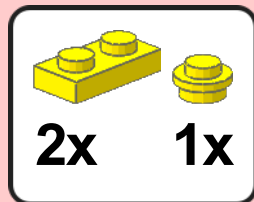

5

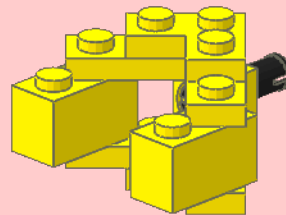
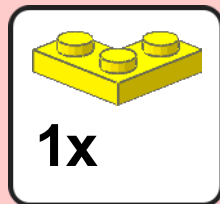

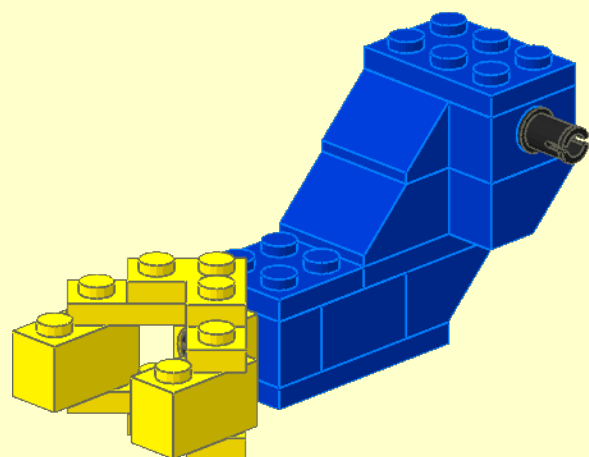

1

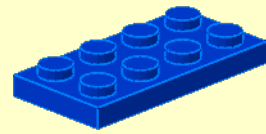
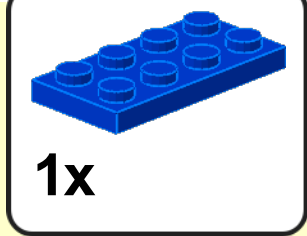

2

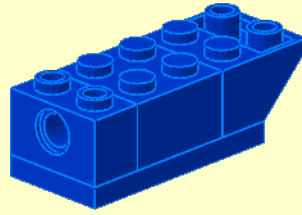
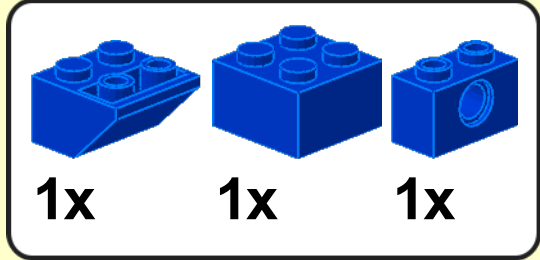

3

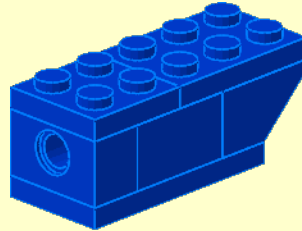
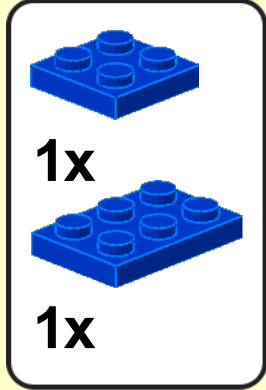

4

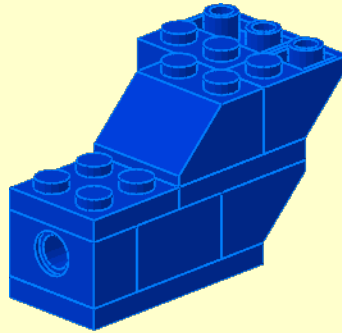
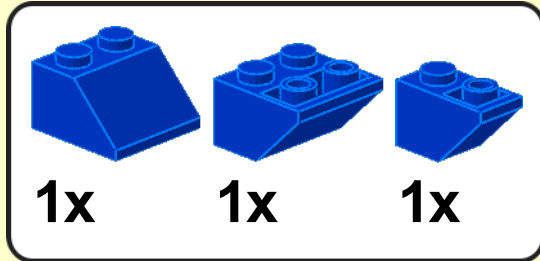

5

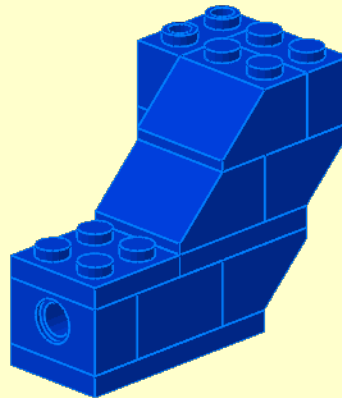
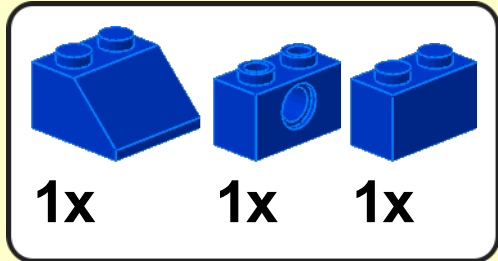

6

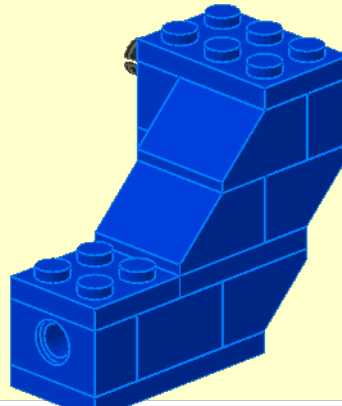
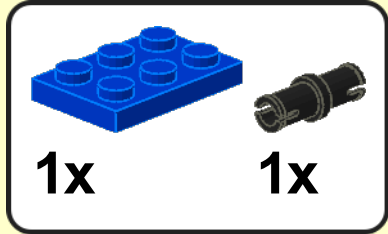

1

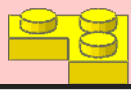
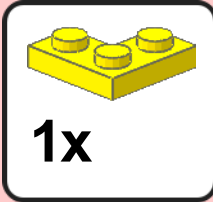

2

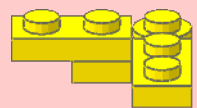
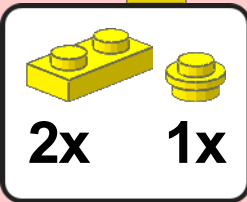

3

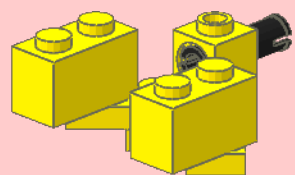
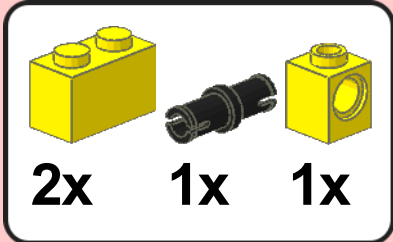

4

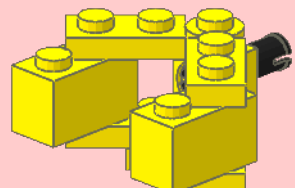
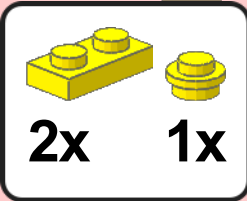

5

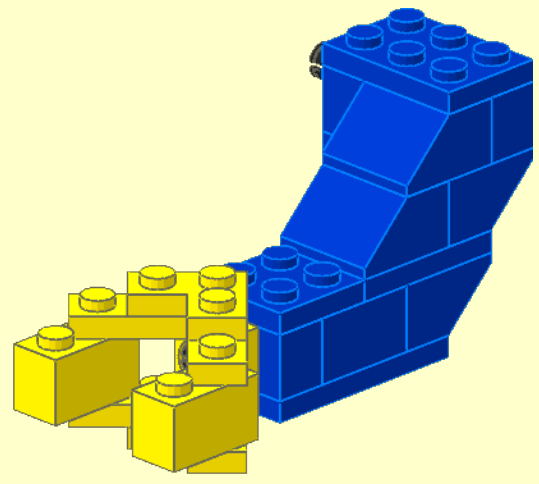
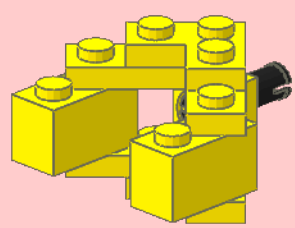
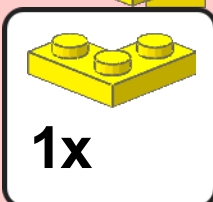

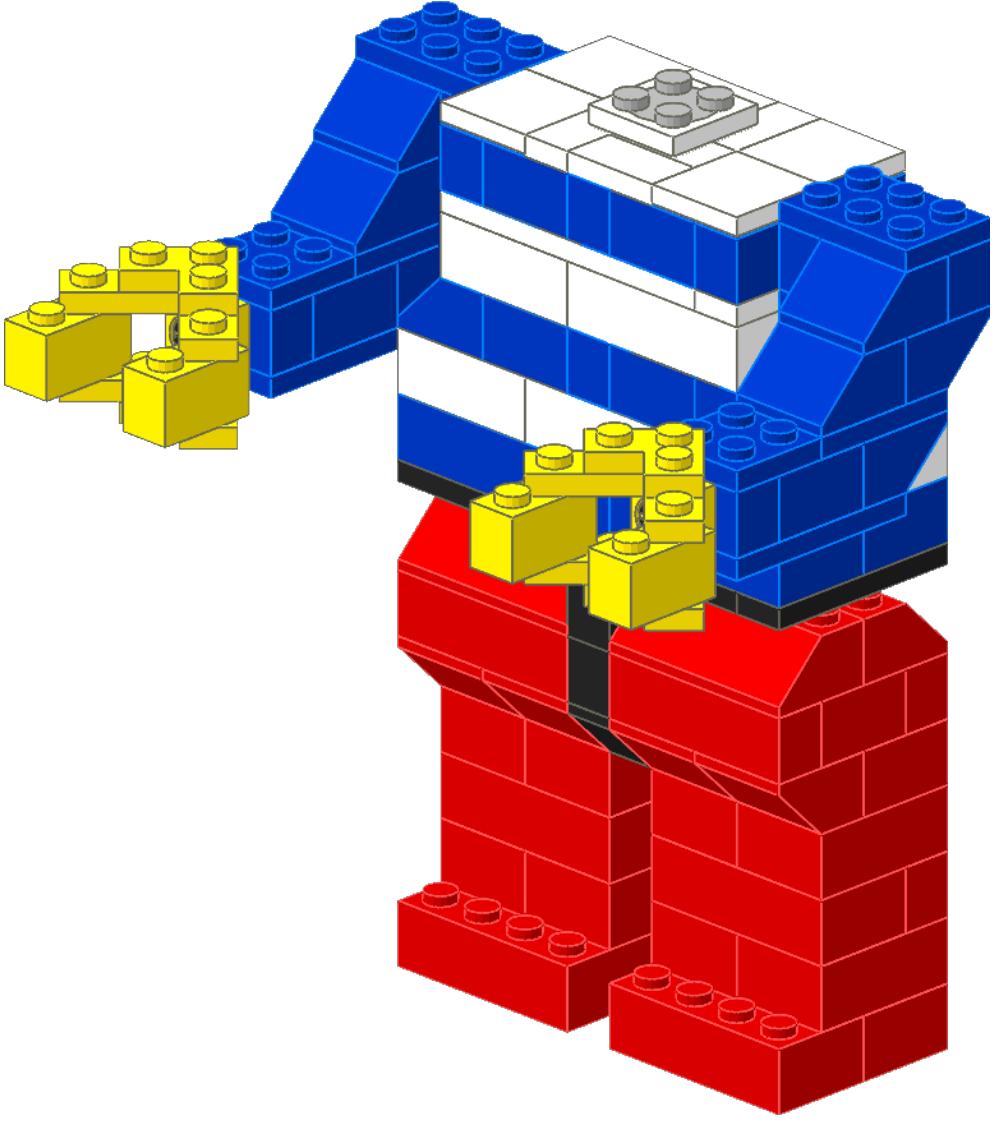



1

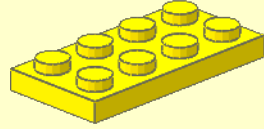
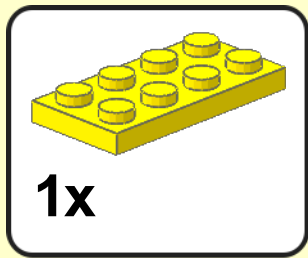

2

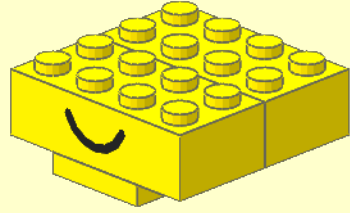
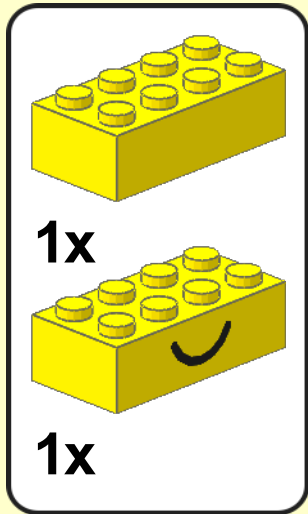

3

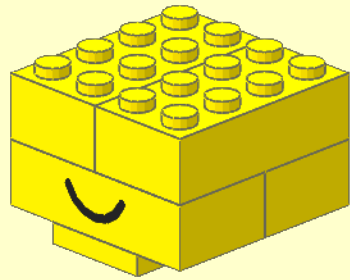
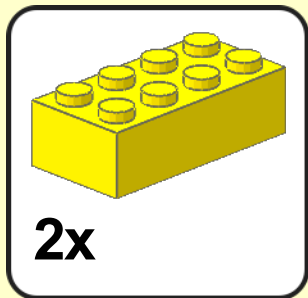

4

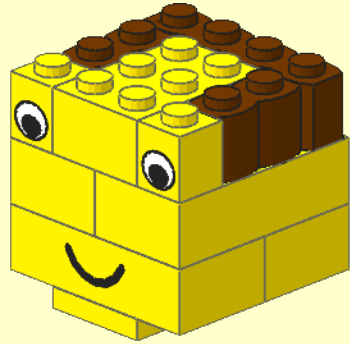
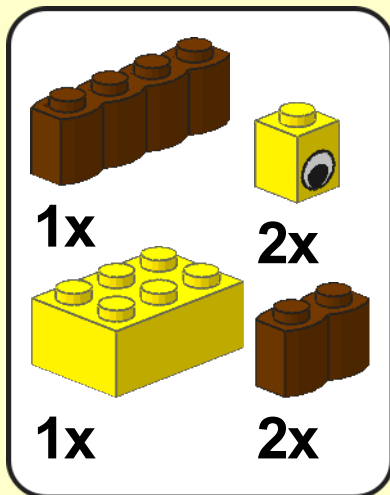

5

